

1

2

3

4

5

6

A

A

B

B

C

C

D

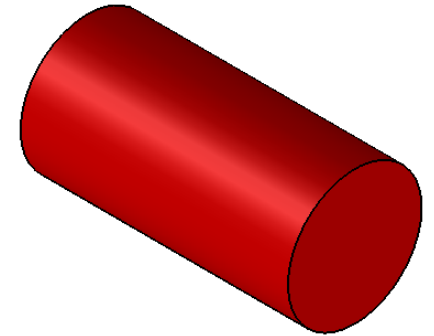
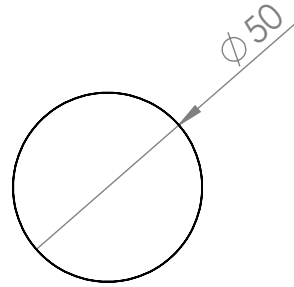
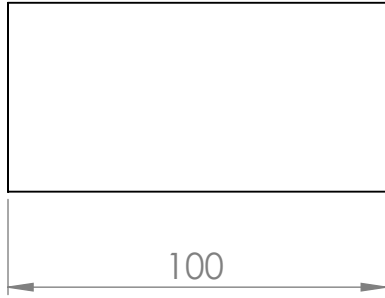

UNLESS OTHERWISE SPECIFIED:
 DIMENSIONS ARE IN MILLIMETERS
 SURFACE FINISH:
 TOLERANCES:
 LINEAR:
 ANGULAR:

FINISH:

DEBUR AND
BREAK SHARP
EDGES

DO NOT SCALE DRAWING

REVISION

	NAME	SIGNATURE	DATE		
DRAWN					
CHK'D					
APPV'D					
MFG					
Q.A					

TITLE:

MATERIAL:

DWG NO.

Part1

A4

WEIGHT:

SCALE:1:1

SHEET 1 OF 1

1

2

1

2

3

4

5

6

A

A

B

B

C

C

D

1

2

1 2 3 4 5 6

A

A

B

B

C

C

D

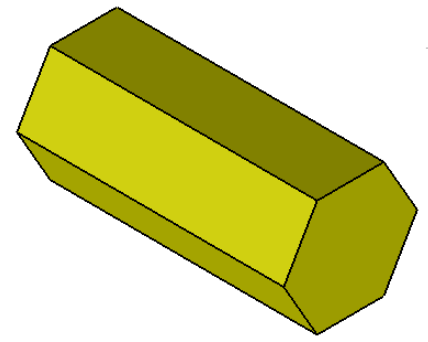
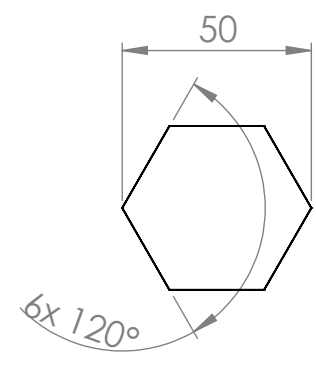
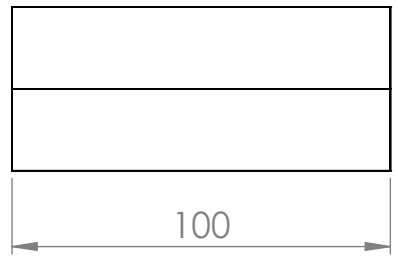

UNLESS OTHERWISE SPECIFIED:
 DIMENSIONS ARE IN MILLIMETERS
 SURFACE FINISH:
 TOLERANCES:
 LINEAR:
 ANGULAR:

FINISH:

DEBUR AND
 BREAK SHARP
 EDGES

DO NOT SCALE DRAWING

REVISION

	NAME	SIGNATURE	DATE		
DRAWN					
CHK'D					
APPV'D					
MFG					
Q.A					

TITLE:

DWG NO. **Part2** A4

1 2 WEIGHT: SCALE:1:1 SHEET 1 OF 1

1 2 3 4 5 6

A

A

B

B

C

C

D

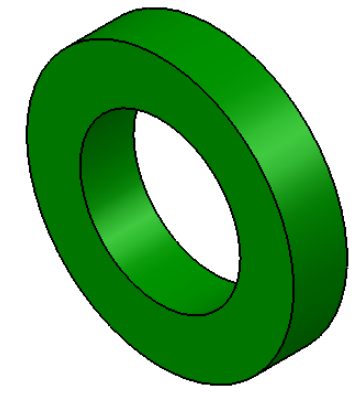
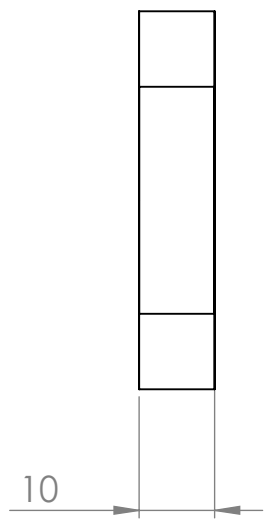
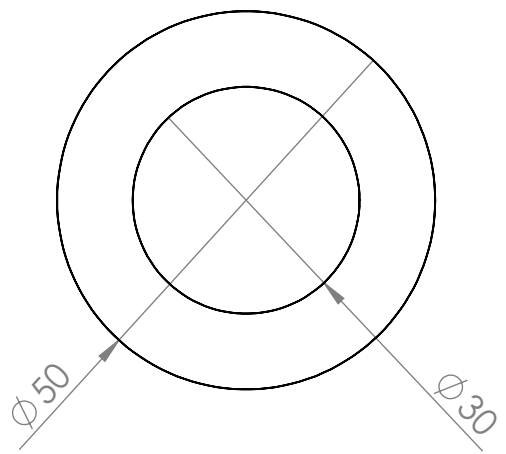

UNLESS OTHERWISE SPECIFIED: DIMENSIONS ARE IN MILLIMETERS SURFACE FINISH: TOLERANCES: LINEAR: ANGULAR:				FINISH:		DEBUR AND BREAK SHARP EDGES		DO NOT SCALE DRAWING		REVISION	
	NAME	SIGNATURE	DATE			TITLE:					
DRAWN											
CHK'D											
APPV'D											
MFG											
Q.A				MATERIAL:		DWG NO.		Part3			A4
				WEIGHT:		SCALE:1:1		SHEET 1 OF 1			

1 2

1

2

3

4

5

6

A

A

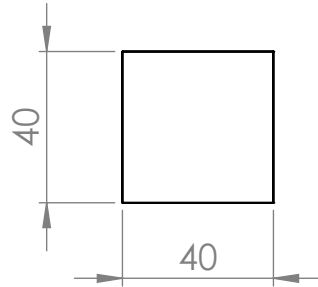
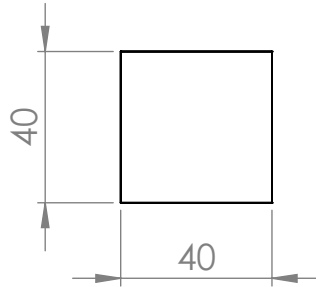

B

B

C

C

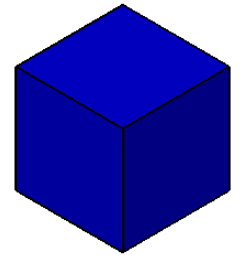

D

UNLESS OTHERWISE SPECIFIED:
 DIMENSIONS ARE IN MILLIMETERS
 SURFACE FINISH:
 TOLERANCES:
 LINEAR:
 ANGULAR:

FINISH:

DEBUR AND
BREAK SHARP
EDGES

DO NOT SCALE DRAWING

REVISION

	NAME	SIGNATURE	DATE		
DRAWN					
CHK'D					
APPV'D					
MFG					
Q.A					
				MATERIAL:	
				WEIGHT:	

TITLE:

DWG NO.

Part4

A4

SCALE:1:1

SHEET 1 OF 1

1

2